

SHS-500 Reference Manual

Contents

The Functions

Tuning

EQ Type

Modulation

Pitch Bend Range

Portamento

Portamento Time

DSP Type

MIDI Select

MIDI Channel

Local Control

Audio Loop Back

Battery Type

Auto power off

How to Use Terminals

[PHONES]

[AUX IN]

[LINE OUT]

[TO HOST]

- Audio data – USB Audio Interface function

- MIDI data

[MIDI]

Troubleshooting

Voice List

- Drum Kit List

Voice Parameters

Effect List

- DSP Type List

MIDI Implementation Chart

The Functions

The various “Functions” let you make detailed settings for the instrument. For the Function menu, see the list on next page.

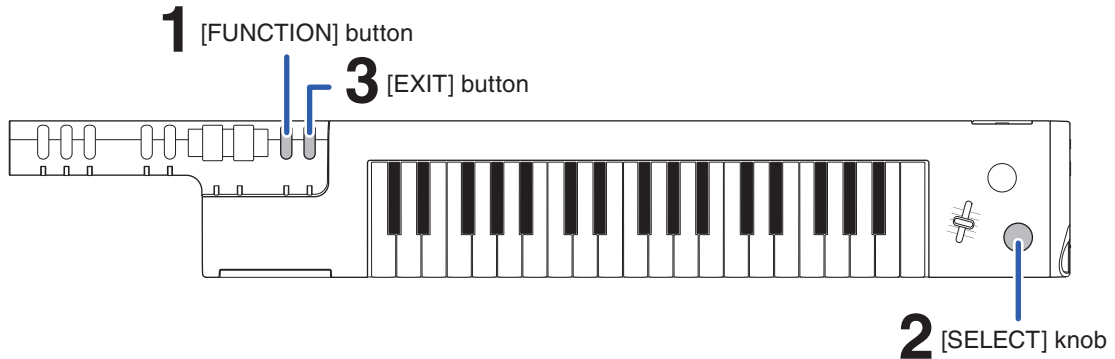

Operation

1. Select the Function menu.

Press the [FUNCTION] button repeatedly to call up the desired Function menu in the upper part of the display. For example, call up “Tuning” if you want to fine-tune the pitch of the entire instrument.

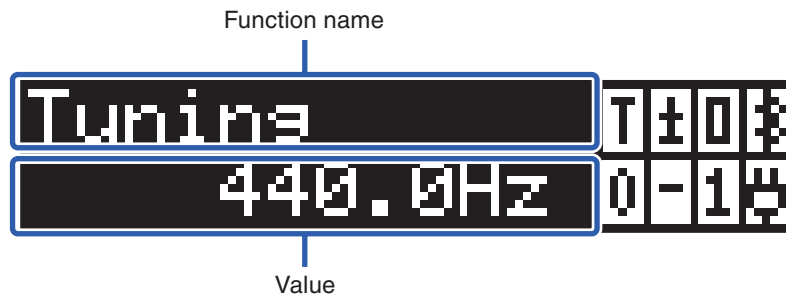

2. Set the value.

Rotate the [SELECT] knob to select the value in the bottom of the display.

3. Press the [EXIT] button to exit from the Function mode.

Function List

Function	Description	Backup
Tuning	<p>You can fine-tune the pitch of the entire instrument in roughly 0.2 Hz steps. This lets you accurately match the keyboard pitch to that of other instruments or recorded music.</p> <p>Tuning doesn't affect drum voices.</p> <p>Value: 427.0 Hz – 453.0 Hz</p> <p>Default: A3 = 440.0 Hz</p>	Yes
EQ Type	<p>Four different master equalizer (EQ) settings give you the best possible sound when listening through different reproduction systems—the instrument's internal speaker, headphones, or an external speaker system.</p> <p>Value: Speaker, Boost, LineOut, Mild</p> <p>Speaker: Optimum for listening via the instrument's built-in speaker.</p> <p>Boost: Results in more powerful sound. Depending on the selected Voice, the sound may be more subject to distortion than other EQ types.</p> <p>LineOut: Optimum for listening via headphones or external speakers connected to the LINE OUT jack. This value will be automatically selected when the headphones are connected.</p> <p>Mild: Lowers the high range for a softer sound.</p> <p>Default: Speaker</p>	Yes
Modulation	<p>Specifies whether the Modulation wheel controls the Vibrato depth (Vibrato) or parameter of the effect selected with the [EFFECT] selector (EfctCtrl).</p> <p>Value: Vibrato / EfctCtrl</p> <p>Default: Vibrato</p>	No
PB Range (Pitch Bend Range)	<p>Determines the amount (in semitones) that pitch is raised or lowered when using the [PITCH] bend wheel.</p> <p>Value: 00 – 12</p> <p>Default: 02</p>	No



The Functions

Function	Description	Backup
Portamento	Portamento is used to create a smooth transition in pitch from one note played on the keyboard to the next one. Determines whether Portamento is applied or not. Value: ON / OFF Default: OFF	No
Porta Time (Portamento Time)	Determines the pitch transition time or rate when Portamento is applied. Higher values result in a longer pitch change time. Value: 000 – 127 Default: 064	No
DSP Type	DSP refers to various digital effects which can be applied to the keyboard Voice. You can select the desired type here. For details, refer to the DSP Type List on page 26 . Value: Dist.1 / Dist.2 / DSP Chrs / Flanger / Phaser / Tremolo / RotarySp / LPF / HPF Default: Depends on the Voice	No
MIDI Select	Selects the MIDI transmit/receive port. Select value “ BLE MIDI ” for Bluetooth® connection, “ USB MIDI ” for [TO HOST] terminal or “ MiniMIDI ” for MIDI terminal. Value: USB MIDI / MiniMIDI / BLE MIDI Default: BLE MIDI NOTE Depending on the country in which you purchased the product, the instrument may not have Bluetooth capability. If this is the case, you cannot select the value “BLE MIDI,” and the default value is “USB MIDI.”	Yes
MIDI CH (MIDI Channel)	Determines the MIDI transmit channel. Value: 01CH, 02CH ... 15CH, 16CH, OFF Default: 01CH	Yes

Function	Description	Backup
Local (Local Control)	<p>Determines whether the instrument's keyboard controls the internal tone generator (On) or not (Off).</p> <p>“Local Control” (normally set to “On”) allows the keyboard of the instrument to “locally” control its internal tone generator, letting you directly play the internal voices from the keyboard. However, for some situations (for example, recording to computer software), you will want to set Local Control to “Off,” so that the keyboard of the instrument does not play the internal voices, but the appropriate MIDI information is still transmitted (for recording) via the [TO HOST] terminal when notes are played on the keyboard. At the same time, the internal tone generator responds to MIDI information received via the [TO HOST] terminal, allowing you to hear the notes you play.</p> <p>Value: ON / OFF Default: OFF</p>	No
LoopBack (Audio Loop Back)	<p>Determines whether Audio sound input from the [TO HOST] terminal is returned to the computer or not with the performance played on the instrument (page 12). If you want to output only the sound played on this instrument to the computer, set this parameter to Off.</p> <p>Value: ON / OFF Default: ON</p>	Yes
Battery (Battery Type)	<p>Selects the type of batteries you have installed to this instrument.</p> <p>Value: Alkaline (for Alkaline, Manganese batteries) / Ni-MH (for rechargeable Ni-MH batteries) Default: Alkaline</p>	Yes
Auto Off (Auto Power Off)	<p>Specifies the time that will elapse before the instrument's power is automatically turned off.</p> <p>Value: Off / 05min / 10min / 15min / 30min / 60min Default: 30min</p>	Yes

How to Use the Terminals

This keyboard has 5 terminals for connecting to external devices. This section shows you what, when and how to connect.

CAUTION

Before connecting the instrument to other electronic components, turn off the power of all the components. Also, before turning any components on or off, make sure to set all volume levels to minimum (0). Otherwise, damage to the components, electrical shock, or even permanent hearing loss may occur.

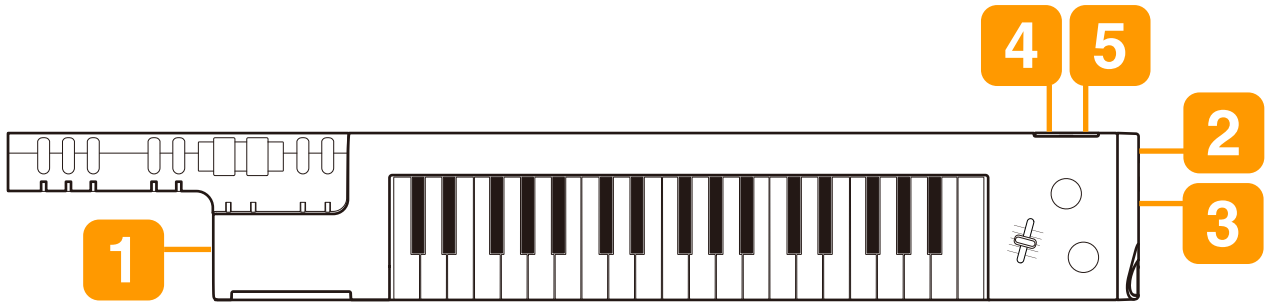

1 [PHONES] for practicing with headphones

For connecting a pair of stereo headphones with a mini stereo phone plug (3.5 mm). The instrument's built-in speaker automatically stops producing sound when headphones are connected to this jack. However, the [LINE OUT] jack continues to output the same sound as the [PHONES] jack.

CAUTION

To prevent hearing loss, avoid using headphones at high volumes for extended periods of time.

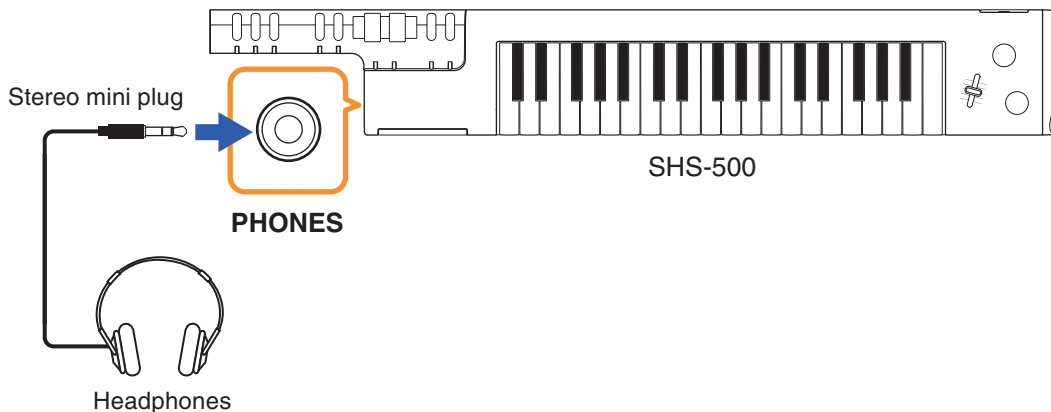

2 [AUX IN] for playing along with an audio player

For inputting the sound of an audio player and listening to it through the built-in speaker of the instrument (with 3.5 mm, mini stereo phone plug). For example, this is convenient for when playing keyboard along with the sound input from an audio player.

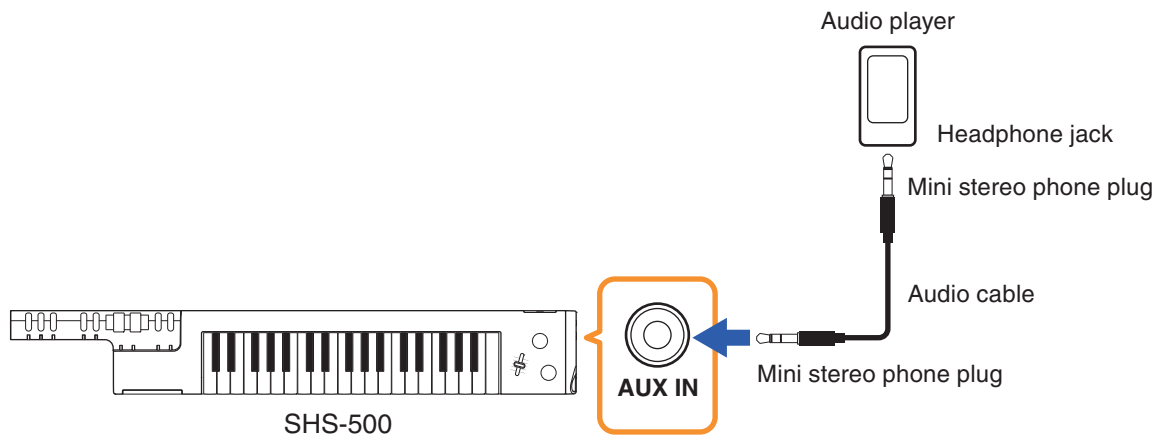

NOTICE

To avoid damage to the devices, first turn on the power to the external device, then to the instrument. When turning off the power, first turn off the power to the instrument, then to the external device.

NOTE

- To adjust the input volume from [AUX IN] jack, adjust the audio playback volume on the audio device.
- Use an appropriate adaptor plug if the output jack of the audio player does not match the stereo mini phone plug of the audio cable.
- Use audio cables and adaptor plugs having no (zero) resistance.

3 [LINE OUT] for higher performance levels

For connecting a powered speaker or a mixing console for playing in larger venues at higher volume (with 1/4" mono phone plug). The sound connected to the instrument's [AUX IN] jack is output at the same time.

For the best sound, set the Function "EQ Type" setting ([page 3](#)) to "LineOut" when using the [LINE OUT] terminal.

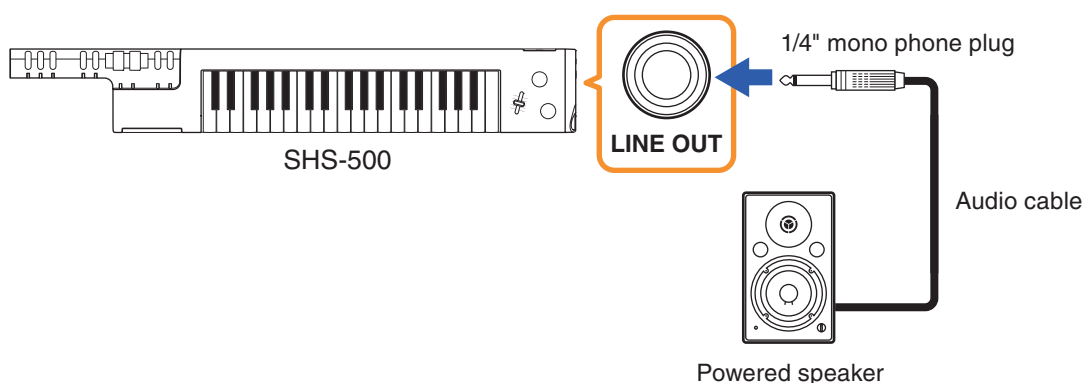

NOTICE

- To avoid possible damage, first turn on the power to the instrument, then to the external device. When turning off the power, first turn off the power to the external device, then to the instrument. Since this instrument's power may automatically be turned off due to the Auto Power Off function ([page 5](#)), turn off the power to the external device, or disable Auto Power Off when you do not intend to operate the instrument.
- Do not route the output from the [LINE OUT] jack to the [AUX IN] jack. If you make this connection, the signal input at the [AUX IN] jack is output from the [LINE OUT] jack and then back again, creating a feedback loop that could make normal performance impossible, and may even damage the equipment.

NOTE

- The instrument's built-in speaker continue to output the same sound as the [LINE OUT] jack when external devices are connected to this jack.
- The output volume from the [LINE OUT] jack does not change when adjusting the [VOLUME] dial on the instrument.
- Use an appropriate adaptor plug if the input jack of the powered speaker does not match the phone plug of the audio cable.
- Use audio cables and adaptor plugs having no (zero) resistance.

4 [TO HOST] for using with smart device or computer

Connecting a smart device or computer allows you to use various functions with just one USB cable, such as sending/receiving MIDI data and high-quality audio data, greatly expanding the potential of the instrument. For smart device connection, a conversion adaptor is needed as shown on [page 10](#).

Transmitting/receiving audio data – USB Audio Interface function

Sending/receiving audio data via digital connection has the following advantages.

- **Playing back audio data with high sound quality**
Enjoy clear, noise-free sound with no degradation of sound quality compared to connecting with the [AUX IN] terminal.
- **Recording the performance of this instrument as audio data on recording software or music production software**
This allows playback of the recorded data with computer or smart device.

Transmitting/receiving MIDI data

Sending/receiving data via MIDI, gives you the following advantages.

- **Playing back MIDI data**
Purchase your favorite song data on the Yamaha website.
- **Recording the performance of the instrument as MIDI data**
When recorded as MIDI data, performances—including the sounds, pitches, note starts, duration, etc.—can be more easily edited using music production software.

NOTE

For basic explanations about what MIDI is and can do, refer to the online PDF manual “MIDI Basics” downloadable from the Yamaha Downloads website:

<https://download.yamaha.com/>

Transmitting/receiving audio data – USB Audio Interface function

Connect this keyboard and your smart device or a computer containing audio data with a USB cable. (Note that audio data cannot be transmitted/received via Bluetooth connection.) You can play back audio data on a smart device or a computer with this instrument. You can also record your keyboard performance as audio data to a music production app on a smart device or a computer.

NOTE

Both MIDI data and audio data can be transmitted simultaneously. To transmit/receive MIDI data from the [TO HOST] terminal, set the Function “MIDI Select” setting ([page 4](#)) to “USB MIDI.”

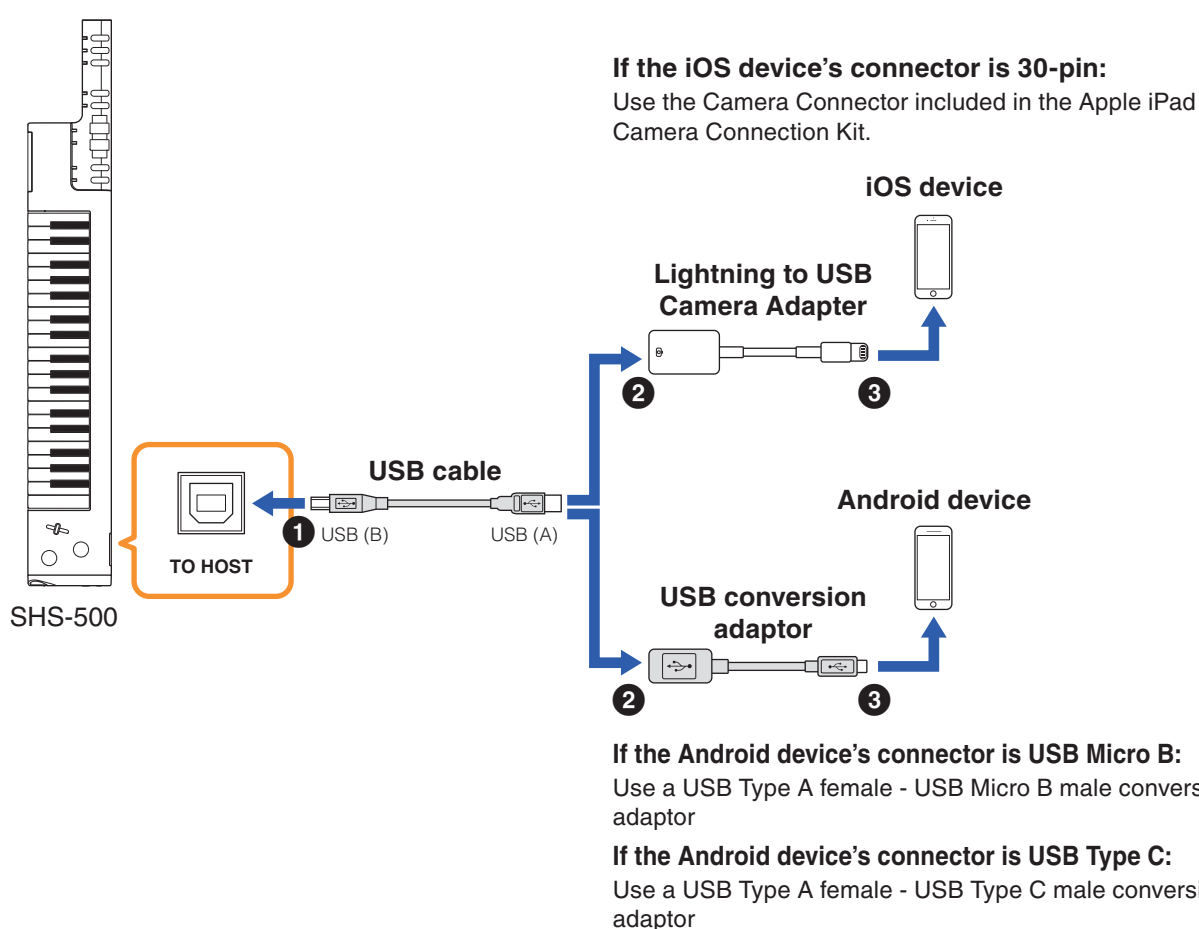

A USB audio interface function is available on a computer as well. When using this function on a computer running Windows, you will need to install the Yamaha Steinberg USB Driver to your computer. For details on using a computer with this instrument, refer to the online PDF manual “Computer-related Operations” downloadable from the Yamaha Downloads website: <https://download.yamaha.com/>



How to Use the Terminals

NOTE

- This instrument is not compatible with the Yamaha file transfer software “Musicsoft Downloader” and so cannot transfer any files.
- You don’t need to set the Function “MIDI Select” setting for transmitting/receiving the audio data.

NOTICE

The USB cable connection will not work correctly if you pull out the USB cable without closing the app during Bluetooth connection. If this happens, turn the power to the instrument on again and then try connect again.

Audio playback

- 1. Turn off the power of the instrument, then connect your smart device or a computer to the instrument with the USB cable.**

For the proper order, carefully follow the indicated instruction steps as illustrated on [page 10](#).

- 2. Turn on the instrument.**

- 3. Playback song (audio data) on the smart device or the computer.**

The sound of the audio data is produced through the built-in speakers of this instrument.

Audio recording

- 1. Turn off the power of the instrument, then connect your smart device or a computer to the instrument with the USB cable.**

For the proper order, carefully follow the indicated instruction steps as illustrated on [page 10](#).

- 2. Turn on the instrument.**

- 3. Recording the performance of this instrument as audio data on recording software or music production software on the smart device or computer.**

For recording operation, refer to the Owner’s Manual supplied with the software. You can record audio data to a Yamaha app “Chord Tracker” as well.

Audio Loop Back

You can set whether Audio sound input from the [TO HOST] terminal is returned to the smart device or the computer or not with the performance played on the instrument by setting the Function “Audio Loop Back” ([page 5](#)). The default setting is on. If you want to output only the sound played on this instrument to the smart device or the computer, set this parameter to off.

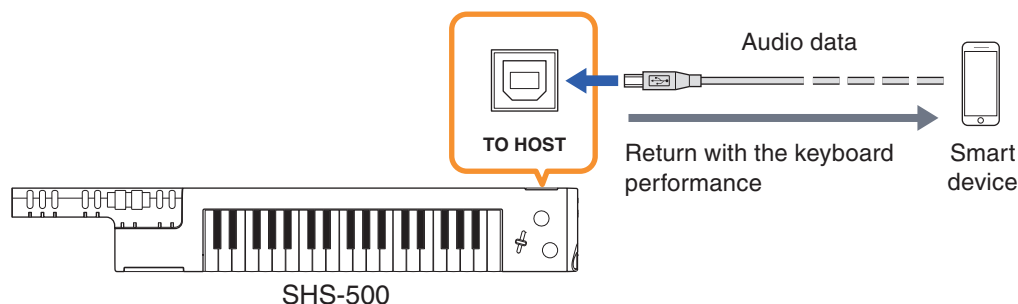

NOTICE

If you are using a DAW (digital audio workstation) with this instrument, set Audio Loop Back ([page 5](#)) to OFF. Otherwise, a loud sound may occur, depending on the settings of the computer or the application software.

Precautions when using the [TO HOST] terminal

When connecting the computer to the [TO HOST] terminal, make sure to observe the following points to avoid freezing the computer and corrupting or losing the data.

NOTICE

- Use an AB type USB cable of less than 3 meters. USB 3.0 cables cannot be used.
- Execute the following before turning the power to the instrument on/off or plugging/unplugging the USB cable to/from the [TO HOST] terminal.
 - Quit any open application software on the computer.
 - Make sure that data is not being transmitted from the instrument. (Data is transmitted only by playing notes on the keyboard or playing back a song.)
- While the computer is connected to the instrument, you should wait for six seconds or more between these operations: (1) when turning the power of the instrument off then on again, or (2) when alternately connecting/disconnecting the USB cable.

If the computer or the instrument freezes, restart the application software or the computer OS, or turn the power to the instrument off then on again.

Transmitting/receiving MIDI data

For connecting to a computer or a smart device via the USB cable to transmitting/receiving MIDI data. This enables you to record your keyboard performance as MIDI data on recording software or music production software on the computer or the smart device, and then play back it on this instrument. To do so, make sure to match the MIDI transmit/receive port (in this case, [TO HOST] terminal) as well as the value of the Function “MIDI Select” setting. For smart device connection, see the illustration on [page 10](#).

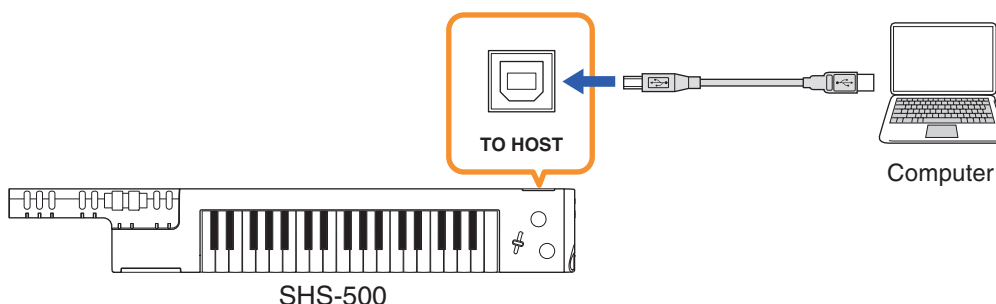

NOTE

This instrument is not compatible with the Yamaha file transfer software “Musicsoft Downloader” and so cannot transfer any files.

1. Confirm that the icon for “USB connection”  is shown in the upper right corner of the display. When the appropriate icon is shown, proceed to step 2. When not, set according to the steps below.

- 1-1** Press the [FUNCTION] button repeatedly to call up the Function menu “MIDI Select” in the upper of the display.
- 1-2** Rotate the [SELECT] knob to select the value “USB MIDI” ([TO HOST] terminal) in the bottom of the display.



2. Press the [EXIT] button to exit from the Function mode.

3. Connect a computer or a smart device to transmit/receive MIDI data.

5 [MIDI] for using as MIDI keyboard

For connecting other MIDI devices via the included MIDI breakout cable and standard MIDI cables (sold separately). This enables you to play a MIDI keyboard from the SHS-500.

To transmit/receive MIDI data, make sure to match the MIDI transmit/receive port (in this case, [MIDI] terminal) as well as the value of the Function “MIDI Select” setting.

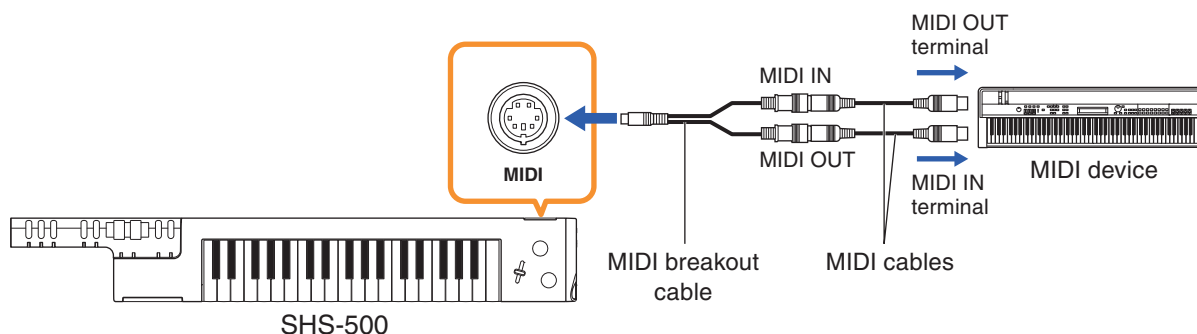

NOTE

This instrument is not compatible with the Yamaha file transfer software “Musicsoft Downloader” and so cannot transfer any files.

1. Confirm that the icon for “MIDI connection”  is shown in the upper right corner of the display. When the appropriate icon is shown, proceed to step 2. When not, set according to the steps below.

1-1 Press the [FUNCTION] button repeatedly to call up the Function menu “MIDI Select” in the upper of the display.

1-2 Rotate the [SELECT] knob to select the value “MiniMIDI” ([MIDI] terminal) in the bottom of the display.



2. Press the [EXIT] button to exit from the Function mode.

3. Connect other MIDI devices to transmit/receive MIDI data.



MIDI transmit channel, Local control

You can specify the MIDI channel to transmit the MIDI data ([page 4](#)), and set the on/off status for the Local Control ([page 5](#)) via the Functions.

Troubleshooting

Q When the instrument is turned on or off, a popping sound is temporarily produced.

A This is normal and indicates that the instrument is receiving electrical power.

Q When using a mobile phone, noise is produced.

A Using a mobile phone in close proximity to the instrument may produce interference. To prevent this, turn off the mobile phone or use it further away from the instrument.

Q Noise is heard from the instrument's speakers or headphones when using the instrument with your smart device, such as an iPhone/iPad.

A When you use the instrument along with the application on your smart device, we recommend that you set that device's "Airplane Mode" to "ON" and then the Bluetooth setting to "ON" on your smart device in order to avoid noise caused by communication.

Q No sound is produced even when the keyboard is played, or a Song is being played back.

A Check whether a set of headphones is connected to the [PHONES], or not. When such a connection is made, no sound is output from the speaker of this instrument.

A Check the on/off status of Local Control ([page 5](#)). Normally, set this parameter to ON.

Q Not all of the Voices seem to sound.

Q The sound seems to be cut off when playing the keyboard or Song.

A You have exceeded 48 simultaneous notes, which is the maximum polyphony (the maximum amount of notes that can be played simultaneously) of this instrument. If the Voices are being used along with playback of Song, some notes/sounds may be omitted (or "stolen").

Q Sound input via the [TO HOST] jack isn't produced from the built-in speaker of the instrument, or it is too low.

A Check that the volume setting is not too low on your smart device.

Q The sound of the Voice changes from note to note.

A This is normal. The tone generation method uses multiple recordings (samples) of an instrument across the range of the keyboard; thus, the actual sound of the Voice may be slightly different from note to note.

Q The volume is too soft.**Q The sound quality is poor.****Q The Song stops unexpectedly or will not play.****Q The LCD display suddenly goes dark, and all panel settings are reset.**

A The batteries are low or dead. Replace all six batteries with completely new ones or completely recharged ones, or use the AC adaptor.

Q The instrument is automatically turned off even if no operation is done.

A This is normal. This occurs due to the Auto Power Off function ([page 5](#)). If you need to disable the Auto Power Off function, select “Off” in the Function settings.

Q When the instrument is turned on, power is turned off suddenly and unexpectedly.

A The protection circuit has been activated due to over current. This may occur when an AC adaptor other than the one specified is used, or an AC adaptor is damaged. Use the specified adaptor only (refer to the Specifications in the Owner’s Manual). If it should appear to be malfunctioning, discontinue use immediately and have it inspected by qualified Yamaha service personnel.

Q Sound input via the [AUX IN] jack isn’t produced from the built-in speaker of the instrument, or it is too low.

A To control the [AUX IN] volume, adjust the volume of the connected audio equipment.

A Use audio cable having no (zero) resistance.

Q Cannot connect with Bluetooth.

- A** Check that the Bluetooth function of the smart device is activated.
- A** Check if another smart device is connected to the keyboard via Bluetooth. If this is the case, disable the Bluetooth function of that smart device, then try connect to the desired smart device again.
- A** The keyboard cannot connect to the smart device via Bluetooth if the computer is connected to the keyboard with a USB cable. When using Bluetooth connection, make sure not to connect any other device with a USB cable.
- A** Check that the smart device is compatible with the app “Chord Tracker” on the Yamaha website:
<https://www.yamaha.com/kbdapps/>

Q USB cable connection doesn't work.

- A** The USB cable connection will not work correctly if you switch from Bluetooth connection to USB cable connection without closing the app. If this is the case, turn the [⏻] (Standby/On) switch off and turn it on again. Then try the operation again.

Q Cannot transmit/receive the audio data to/from the external audio device.

- A** Audio data is not available with Bluetooth connection. Use USB cable connection.

Q “!” is shown in the display.

- A** The protection circuit has been activated due to over current. Disconnect the USB device from the [TO HOST] terminal, then turn on the power of the instrument again.

Voice List



Select a Voice with the [SELECT] knob.

No.	Voice	Display	MSB	LSB	PC1
001	Saw Lead 1	SawLead1	104	20	91
002	Saw Lead 2	SawLead2	0	104	82
003	Quack Lead	QuackLd	0	112	85
004	Bright Decay	BriteDcy	104	21	85
005	Square Lead	SquareLd	0	112	81
006	Under Heim	UndrHeim	104	51	88
007	Analogon	Analogon	104	52	82
008	Synth Brass	SynBrass	0	113	64
009	Electric Piano	E.Piano	104	28	5
010	DX Electric Piano	DXPiano	0	112	6
011	Electric Guitar	E.Guitar	104	3	31
012	Jazz Guitar	J.Guitar	104	0	27
013	Acoustic Guitar	A.Guitar	0	117	26
014	Electric Bass	E.Bass	104	6	34
015	Slap Bass	SlapBass	0	112	37
016	Synth Bass	SynBass	0	112	39
017	DX Bass	DXBass	0	118	40
018	Piano	Piano	0	112	2
019	Piano & Strings	Pno&Strs	104	39	1
020	Piano & Pad	Pno&Pad	104	40	1
021	Air Choir	AirChoir	0	112	55
022	Strings	Strings	0	116	49
023	Brass	Brass	0	117	63
024	Trumpet	Trumpet	0	115	57
025	Flute	Flute	0	115	74
026	Alto Sax	AltoSax	104	2	66
027	Tenor Sax	TenorSax	104	3	67
028	Harmonica	Harmnica	0	112	23
029	House Kit	HouseKit	127	0	65
030	Power Kit	PowerKit	127	0	88

Voices No. 029 and 030 are Drum Kits. When you select a Drum Kit, various drum and percussion sounds are assigned to individual keys, from which they can be played. Details on the instruments and key assignments of each Drum Kit can be found in the Drum Kit List on [page 20](#).



Drum Kit List

The MIDI Note # and Note are actually one octave lower than the keyboard Note # and Note. For example, in “House Kit,” the “Kick T9 5” (Note #48/Note C2) corresponds to MIDI (Note #36/Note C1).

Keyboard			MIDI			1 org	127-000-65	127-000-88
						0 org	127-000-64	127-000-87
Note#	Note	Note	Note#	Note	Note	House Kit	Power Kit	
25	C# 0	C#0	13	C# -1	C#-1	W Kick	Surdo Mute	
26	D 0	D0	14	D -1	D-1	Surdo Open	Surdo Open	
27	D# 0	D#0	15	D# -1	D#-1	Hi Q	Hi Q	
28	E 0	E0	16	E -1	E-1	Whip Slap	Whip Slap	
29	F 0	F0	17	F -1	F-1	Scratch H	Scratch H	
30	F# 0	F#0	18	F# -1	F#-1	Scratch L	Scratch L	
31	G 0	G0	19	G -1	G-1	W Noise up	Finger Snap	
32	G# 0	G#0	20	G# -1	G#-1	Tom T8 3	Click Noise	
33	A 0	A0	21	A -1	A-1	Hi-Hat Open T8 1	Metronome Click	
34	A# 0	A#0	22	A# -1	A#-1	Tom T8 6	Metronome Bell	
35	B 0	B0	23	B -1	B-1	Crash T8	Seq Click L	
36	C 1	C1	24	C 0	C0	Kick T9 4	Seq Click H	
37	C# 1	C#1	25	C# 0	C#0	Snare T8 Rim	Brush Tap	
38	D 1	D1	26	D 0	D0	Snare T8 5	Brush Swirl	
39	D# 1	D#1	27	D# 0	D#0	Clap Analog Sm	Brush Slap	
40	E 1	E1	28	E 0	E0	Snare Garage L	Brush Tap Swirl	
41	F 1	F1	29	F 0	F0	Snare Rock Roll Distortion	Snare Roll	
42	F# 1	F#1	30	F# 0	F#0	Snare T9 3	Castanet	
43	G 1	G1	31	G 0	G0	Snare T8 1	Snare Soft Power	
44	G# 1	G#1	32	G# 0	G#0	Snare T9 5	Sticks	
45	A 1	A1	33	A 0	A0	Kick T9 1	Kick Amb+	
46	A# 1	A#1	34	A# 0	A#0	Snare T9 Gate	Open Rim Power	
47	B 1	B1	35	B 0	B0	Kick T9 2	Kick Power Open	
48	C 2	C2	36	C 1	C1	Kick T9 5	Kick Power Closed	
49	C# 2	C#2	37	C# 1	C#1	Snare T9 Rim	Side Stick Power	
50	D 2	D2	38	D 1	D1	Snare T9 1	Snare Power	
51	D# 2	D#2	39	D# 1	D#1	Clap T9	Hand Clap Power	
52	E 2	E2	40	E 1	E1	Snare T9 2	Snare Rough	
53	F 2	F2	41	F 1	F1	Tom T9 1	Tom Power 1	
54	F# 2	F#2	42	F# 1	F#1	Hi-Hat Close T8 1	Hi-Hat Closed Power	
55	G 2	G2	43	G 1	G1	Tom T9 2	Tom Power 2	
56	G# 2	G#2	44	G# 1	G#1	Hi-Hat Pedal T9	Hi-Hat Pedal Power	
57	A 2	A2	45	A 1	A1	Tom T9 3	Tom Power 3	
58	A# 2	A#2	46	A# 1	A#1	Hi-Hat Open T9	Hi-Hat Open Power	
59	B 2	B2	47	B 1	B1	Tom T9 4	Tom Power 4	



Voice List

		Keyboard			MIDI		1 org	127-000-65	127-000-88
		Note#	Note	Note	Note#	Note	Note	127-000-64	127-000-87
								House Kit	Power Kit
C3		60	C 3	C3	48	C 2	C2	Tom T9 5	Tom Power 5
	C#3	61	C# 3	C#3	49	C# 2	C#2	Crash T9	Crash Cymbal Acoustic 1
D3		62	D 3	D3	50	D 2	D2	Tom T9 6	Tom Power 6
	D#3	63	D# 3	D#3	51	D# 2	D#2	Ride T9	Ride Cymbal Acoustic 1
E3		64	E 3	E3	52	E 2	E2	Crash Cymbal 4	Chinese Cymbal Acoustic
F3		65	F 3	F3	53	F 2	F2	Ride Cymbal Cup 2	Ride Cymbal Cup Acoustic
	F#3	66	F# 3	F#3	54	F# 2	F#2	Tambourine Hit	Tambourine
G3		67	G 3	G3	55	G 2	G2	Crash Cymbal 3	Splash Cymbal Acoustic
	G#3	68	G# 3	G#3	56	G# 2	G#2	Cowbell 1	Cowbell
A3		69	A 3	A3	57	A 2	A2	Crash Cymbal 2	Crash Cymbal Acoustic 2
	A#3	70	A# 3	A#3	58	A# 2	A#2	Vibraslap	Vibraslap
B3		71	B 3	B3	59	B 2	B2	Ride Cymbal 3	Ride Cymbal Acoustic 2
C4		72	C 4	C4	60	C 3	C3	Bongo High Open 1F	Bongo H
	C#4	73	C# 4	C#4	61	C# 3	C#3	Bongo Low Open 3F	Bongo L
D4		74	D 4	D4	62	D 3	D3	Conga High Tip	Conga H Mute
	D#4	75	D# 4	D#4	63	D# 3	D#3	Conga High Slap Open	Conga H Open
E4		76	E 4	E4	64	E 3	E3	Conga High Open	Conga L
F4		77	F 4	F4	65	F 3	F3	Timbale H	Timbale H
	F#4	78	F# 4	F#4	66	F# 3	F#3	Timbale L	Timbale L
G4		79	G 4	G4	67	G 3	G3	Agogo H	Agogo H
	G#4	80	G# 4	G#4	68	G# 3	G#3	Agogo L	Agogo L
A4		81	A 4	A4	69	A 3	A3	Cavasa House	Cabasa
	A#4	82	A# 4	A#4	70	A# 3	A#3	Maracas Slur	Maracas
B4		83	B 4	B4	71	B 3	B3	Fx Gun 2	Samba Whistle H
C5		84	C 5	C5	72	C 4	C4	Fx Gun 1	Samba Whistle L
		85	C# 5	C#5	73	C# 4	C#4	Analog Shaker H	Guiro Short
		86	D 5	D5	74	D 4	D4	Analog Shaker L	Guiro Long
		87	D# 5	D#5	75	D# 4	D#4	Claves T8	Claves
		88	E 5	E5	76	E 4	E4	Hi Q 1	Wood Block H
		89	F 5	F5	77	F 4	F4	Hi Q 2	Wood Block L
		90	F# 5	F#5	78	F# 4	F#4	Scratch L	Cuica Mute
		91	G 5	G5	79	G 4	G4	Scratch L 2	Cuica Open
		92	G# 5	G#5	80	G# 4	G#4	Triangle Mute	Triangle Mute
		93	A 5	A5	81	A 4	A4	Triangle Open	Triangle Open
		94	A# 5	A#5	82	A# 4	A#4	Analog Shaker	Shaker
		95	B 5	B5	83	B 4	B4	Sleigh Bell	Jingle Bells
		96	C 6	C6	84	C 5	C5	Bell Tree	Bell Tree
		97	C# 6	C#6	85	C# 5	C#5	Snare Hip 1	
		98	D 6	D6	86	D 5	D5	Snare Hip 2	
		99	D# 6	D#6	87	D# 5	D#5	Vox Bell	



Voice List

Keyboard			MIDI			1 org	127-000-65	127-000-88
						0 org	127-000-64	127-000-87
Note#	Note	Note	Note#	Note	Note	House Kit	Power Kit	
100	E 6	E6	88	E 5	E5	Snare Break		
101	F 6	F6	89	F 5	F5	Vox ALK		
102	F# 6	F#6	90	F# 5	F#5	Snare Fx		
103	G 6	G6	91	G 5	G5	Kick Fx Hammer		

: No sound

Voice Parameters

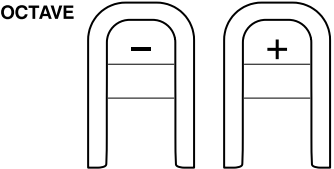
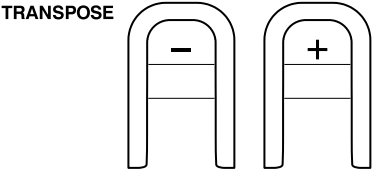
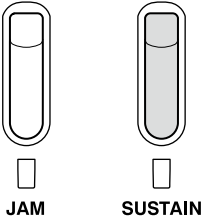
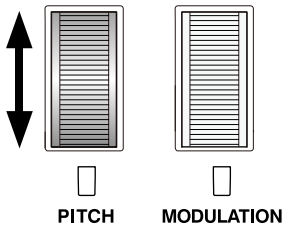
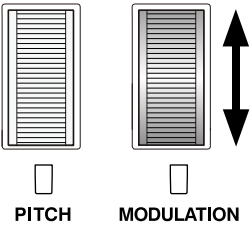
Parameter	Description
<p>Octave</p> 	<p>For shifting the pitch of the keyboard up or down by one octave.</p> <p>Octave affects only notes played after pressing the button. It does not affect notes that are already playing when it is pressed.</p> <p>Setting value: -2 – +2</p> <p>Default: Depends on the Voice</p>
<p>Transpose</p> 	<p>For transposing the pitch of the keyboard up or down in semitones.</p> <p>Transpose affects only notes played after pressing the button. It does not affect notes that are already playing when it is pressed.</p> <p>Setting value: -12 – +12</p> <p>Default: 0</p>
<p>Sustain</p> 	<p>While holding down this button, the notes you play have a longer sustain.</p> <p>Setting value: ON, OFF</p> <p>Default: OFF</p>
<p>Pitch bend</p> 	<p>For adding smooth pitch variations to notes you play on the keyboard.</p> <p>The maximum pitch bend range can be changed via the Function.</p> <p>Setting value: 0 – 16383 (MIDI)</p> <p>Default: 8192 (CENTER)</p>
<p>Modulation</p> 	<ul style="list-style-type: none"> For applying a vibrato effect to notes played on the keyboard. For changing the parameter of the effect which is selected with the [EFFECT] selector. (This is available only when the Function setting “Modulation” value is set to “EfctCtrl”). <p>Setting value: 0 – 127</p> <p>Default: 0</p>

Effect List

Select the desired effect with the [EFFECT] selector then set its value with the [EFFECT CONTROL] knob.

Effect	Description
--------	-------------

FILTER



NOTE

Effect name and its value will appear in the display for a few seconds. This is same as the following effects.

Filter shapes the sound by allowing only a specified range of frequencies to pass and/or by producing a resonance peak at the “cutoff” frequency. Filter can be used to create a range of synthesizer-like sounds.

Filter has two internal parameters Cutoff and Resonance. Making a setting here automatically changes the setting of these parameters as well.

Cutoff:

Adjusts the cutoff frequency, and therefore the brightness of the sound. The higher the value, the brighter the sound.

Resonance:

Adjusts the amount of Resonance applied at the cutoff frequency. The higher value increases the Resonance to emphasize the frequencies at the cutoff frequency, resulting in an exaggerated peak.

Selecting another Voice resets both Cutoff and Resonance to 64.

Setting value: 0 – 127

Default: Cutoff: 64, Resonance: 64

DYNAMICS





Sets the touch sensitivity of the keyboard. Lower values produce greater volume variation in response to keyboard dynamics—in other words, providing greater sensitivity and making it easier to produce wide dynamic changes. Higher values produce a more uniform response—in other words, providing less sensitivity and making it easier to produce loud sounds in your performance.

Selecting another Voice resets the effect depth value you have set.

Setting value: 0 – 127

Default: Depends on the Voice

Effect	Description
<p>REVERB</p>  <p>Reverb Setting value</p>	<p>Adds the ambience of a club or concert hall to the sound. The higher the value, the greater the effect.</p> <p>Selecting another Voice resets the effect depth value you have set.</p> <p>Setting value: 0 – 127 Default: Depends on the Voice</p>
<p>CHORUS</p>  <p>Chorus Setting value</p>	<p>Produces a rich “fat” sound as if several parts are being played simultaneously. The higher the value, the greater the effect.</p> <p>Selecting another Voice resets the effect depth value you have set.</p> <p>Setting value: 0 – 127 Default: Depends on the Voice</p>
<p>OTHER</p>  <p>Other Setting value</p>	<p>Adjusts the parameters of the DSP effect selected by the Function. Selecting another Voice resets the effect depth value you have set.</p> <p>In the default setting, the optimum DSP type for the selected Voice is automatically called up.</p> <p>DSP will be turned off when turning the power to the instrument on or when the DSP parameter is set to 0. DSP will be turned on if the value is changed.</p> <p>Setting value: 0 – 127 Default: Depends on the Voice</p>

NOTE

The effect depth value can be controlled by the [EFFECT CONTROL] knob and the Modulation wheel (if set via the Functions). If both are used to set the value, priority will be given to the last used one. For example, the value will be set to minimum if you decrease the value with the [EFFECT CONTROL] knob even when the Modulation wheel has been set to the maximum position.



DSP Type List

DSP Type	Display	Description
Distortion 1	Dist.1	Adds an “edgy” distortion to the sound. For powerful guitar sound of Rock and Blues, it is an indispensable effect.
Distortion 2	Dist.2	There are two different types (Distortion 1 and 2). Turn the Knob to adjust the degree of the distortion effect.
DSP Chorus	DSP Chrs	Adds warm modulation to the sound. Turn the Knob to change the modulation speed.
Flanger	Flanger	Creates a swirling, metallic sound similar to that of a jet airplane. Turn the Knob to change the modulation speed.
Phaser	Phaser	Cyclically modulates the phase to add modulation to the sound. Turn the Knob to adjust the modulation speed.
Tremolo	Tremolo	Rich Tremolo effect with volume modulation. Turn the Knob to adjust the modulation speed.
Rotary Speaker	RotarySp	Simulates the characteristic effect of a rotary speaker. Turn the Knob to change the rotating speed.
Low Pass Filter	LPF	Modifies the tonal color of the sound by cutting the signals above the Cutoff Frequency. Turn the Knob to adjust the cutoff frequency.
High Pass Filter	HPF	Modifies the tonal color of the sound by cutting the signals below the Cutoff Frequency. Turn the Knob to adjust the cutoff frequency.

MIDI Implementation Chart



Yamaha [Digital Keyboard]
Model SHS-500RD, SHS-500B MIDI Implementation Chart

Date : 26-Feb-2019
Version : 1.01

Function...	Transmitted	Recognized	Remarks
Basic Channel Default Changed	1 - 16 1 - 16	1 - 16 ×	
Mode Default Messages Altered	3 × *****	3 × ×	
Note Number : True voice	12 - 120 *****	0 - 127 0 - 127	
Velocity Note ON Note OFF	○ 9nH,v=1-127 × 9nH,v=0	○ 9nH,v=1-127 ×	
After Touch Key's Ch's	× ×	× ×	
Pitch Bend	○	○	
Control Change	0,32 × 1 ○ 5,65 × 6 × 38 × 7,10 × 11 × 64 × 71,72,73,74 × 84 × 91,93 × 96,97 × 100,101 ×	○ ○ ○ ○ ○ ○ ○ ○ ○ ○ ○ ○ ○ ○	Bank Select Modulation Portamento Data Entry (MSB) Data Entry (LSB) Main Volume,Pan Expression Sustain Sound Control Portamento Control Effect Depth RPN Inc,Dec RPN LSB,MSB
Prog Change : True #	× *****	○ 0 - 127	
System Exclusive	○	○	
Common : Song Pos. : Song Sel. : Tune	× × ×	× × ×	
System : Clock Real Time: Commands	○ ○	× ×	
Aux : All Sound Off : Reset All Cntrls : Local ON/OFF Mes- : All Notes Off sages: All Notes Off : All Sound Off : Active Sense : Reset	○ ○ × ○ × × ○ ×	○ (120) ○ (121) ○ (122) ○ (123) ○ (124-125) ○ (126,127) ○ ×	
Notes:			

Mode 1 : OMNI ON , POLY
Mode 3 : OMNI OFF, POLY

Mode 2 : OMNI ON , MONO
Mode 4 : OMNI OFF, MONO

○ : Yes
× : No

- The illustrations and LCD screens as shown in this manual are for instructional purposes only, and may appear somewhat different from those on your instrument.
- The company names and product names in this manual are the trademarks or registered trademarks of their respective companies.